

**AT80K-35, AT80K-35X,
AT80K-35L, AT80K-35H,
AT80K-35K**

OWNER'S MANUAL



ALTIS
E-POWERSPORTS

This Owner's Manual contains important safety information.
Read this Owner's Manual carefully before riding and keep
it in a safe place after reading it.
The rider must have a valid driver's license.

www.altispowersports.com

**ELECTRIFY
YOUR
FREEDOM**



Introduction

Thank you for purchasing ALTIS electric motorcycle. We wish you a safe and enjoyable ride on your future journey!

Read this Owner's Manual carefully before operating this vehicle and keep it in a safe place after reading it. It contains instructions on the vehicle's operation, troubleshooting and maintenance, as well as guidelines on how to safeguard yourself and others from trouble and injury.

It provides the latest information at the time of printing. As our products are constantly being improved, there may be some differences between your vehicle and that described in this manual. Please refer to the actual product.

We reserve the right to make changes to this manual at any time without prior notice and assume no liability for such changes.

Unauthorized modifications to the vehicle are prohibited.

People who are 14 years of age or older are permitted to use this vehicle.

This manual applies to the following models: AT80K-35, AT80K-35X, AT80K-35L, AT80K-35H and AT80K-35K, with illustrations based on the AT80K-35 model. (AT80K-35 and AT80K-35X are not intended for riding on roads.)

If you have any questions about this manual, consult after-sales service from whom you purchased the vehicle.

© 2026 Altit Powersports Inc. All rights reserved.

No part of this manual may be reproduced without written permission of Altit Powersports Inc.

Printed in January, 2026

Table of Contents

1. Important Information	
1.1 Warning Symbols	4
1.2 Vehicle Warning Labels	5
1.3 Vehicle Information	7
1.4 Smartphone App	9
2. Safe Riding	
2.1 Safety Guidelines	10
3. Vehicle Overview	
3.1 Main Components	14
3.2 Electrical Components	16
3.3 Handlebar Switches	17
3.4 Meters	18
3.5 NFC Cards and Spare Mechanical Keys	20
3.6 Charging Ports	21
3.7 Kickstand Power-Off Switch	23
3.8 Seat	23
4. Operating Guidelines	
4.1 Meter Settings	24
4.2 Bluetooth Function	38
4.3 OTA Update	38
5. Riding Guidelines	
5.1 Pre-Ride Check	40
5.2 Starting the Vehicle	41
5.3 Riding	43
5.4 Braking	43
5.5 Parking	44
5.6 Push Assistance	45
6. Battery and Charging	
6.1 Power Battery	46
6.2 Battery Installation and Removal	47
6.3 Charger	48
6.4 How to Charge	49
7. Maintenance	
7.1 Maintenance Schedule	52
7.2 Motor, Controller	54
7.3 Gear Oil	54
7.4 Tires	55
7.5 Brake Fluid	57
7.6 Brake Pads and Brake Discs	58
7.7 Kickstand	59
7.8 Throttle Grip	59



Table of Contents



7.9	Chain, Spoke.....	60
8. Troubleshooting		
8.1	Troubleshooting of Common Malfunctions.....	62
8.2	List of Fault Codes	65
9. Other Information		
9.1	Caring for Your Vehicle	70
9.2	Storing Your Vehicle	70
9.3	Transporting Your Vehicle.....	71
10. Specifications		
11. Electrical Schematic		
12. Index		



1. Important Information

1.1 Warning Symbols

Particularly important information is distinguished in this manual by the following symbols. To ensure your safety and the safety of others, when the following symbols appear, be sure to read their contents carefully and follow the instructions.

 DANGER	Failure to follow the instructions will result in serious injury or death.
 WARNING	Failure to follow the instructions may result in serious injury or death.
 CAUTION	Failure to follow the instructions may result in injury.
 NOTICE	Special precautions are required to prevent damage to your vehicle or other property.

Your safety and the safety of others are very important. It is your responsibility as the owner to operate the vehicle safely and properly. Operation procedures related to the safety symbols and other information are provided in this manual to help you make the right decisions regarding safety.

The information is intended to alert you of potential hazards that may harm you or others.
Be sure to follow these instructions to safely operate and properly maintain your vehicle.

Important Information

1.2 Vehicle Warning Labels

Read all warning labels on the vehicle carefully. These labels contain important safety information that must be observed while riding.



High-temperature warning label



High-voltage warning label



Discharge port high-voltage warning label



Charging port warning label

Important Information

⚠ WARNING

- This vehicle is designed and manufactured for off-road use only. It does not conform to Federal Motor Vehicle Safety Standards, and operation on public streets, roads, or highways is illegal.
- Rider should wear full set protective apparel and gear to avoid physical injury.
- Rider should have off-road riding knowledge and skills, and beginners must ride under supervision and guidance of parents.
- To reduce risk of injury, we strongly recommend that you read the owner's manual before riding.

Safe riding warning label 1

📄 NOTICE

If you need to replace the battery, perform the following steps:

1. Turn off the vehicle.
2. Open the seat lock and flip the seat forward.
3. Remove the battery pressure plate and replace the battery.
4. Check that the battery is properly installed and energized.

Safe riding warning label 2

Tire pressure:25Kpa Max rider weight:220lbs Chain spec:520H

Chain/Tire pressure/Load warning label

Important Information

1.3 Vehicle Information

The frame number, product plate and motor number are unique identifications of your vehicle.

These are required when registering your vehicle. They may also be required by after-sales service when ordering replacement parts.

Refer to the illustrations below to find the information on your vehicle.

➤ Frame Number

The frame number is located on the right side of the steering column.

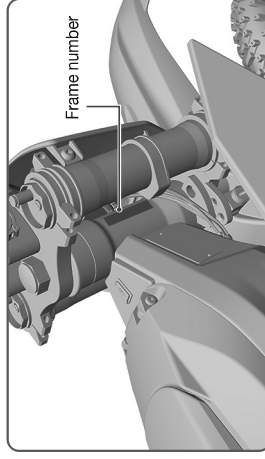

➤ Product Plate

The product plate is located on the right side of the body and near the steering column.

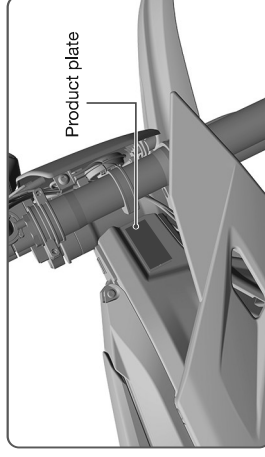

Important Information

▶ Motor Number

The motor number is located at the rear of the motor.

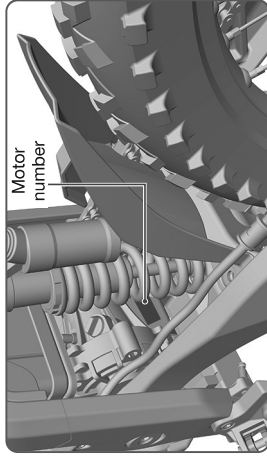



Important Information

1.4 Smartphone App

You can use the app installed on your smartphone to register and OTA upgrade your vehicle.

App features may be updated with new versions of the app.

For iOS devices, search for "Hicycle" in App Store to download.

For Android devices, search for "Hicycle" in Google Play to download.



2. Safe Riding

2.1 Safety Guidelines

As the owner, you are responsible for operating the vehicle safely and properly. Each rider should be familiar with the following requirements before riding the vehicle.

- The rider should undergo proper training in safe riding techniques and obtain the relevant certification.
- Operate this vehicle in compliance with local traffic safety regulations.
- Follow all warnings, instructions, and maintenance requirements provided in this manual.

➤ Riding Equipments

Riding equipments are essential to ensure your safety and comfort. Be sure to select the appropriate certified riding equipments based on the actual weather and road conditions.

Helmet

Choose a helmet that meets national standards, is highly visible, and fits properly.



WARNING

A helmet must be worn at all times while riding. A full-face helmet with face shield is recommended.

Gloves

Full-finger leather gloves with abrasion resistance are recommended.

Boots

Wear protective boots that fit well without affecting your riding.

Clothing

Protective, highly visible, long-sleeved jacket and durable trousers for riding (or a motorcycle riding suit).

Rain Gear

When riding under rainy or wet conditions, it is recommended to wear a raincoat or waterproof riding suit. For long-distance riding, it is recommended to carry rain gear. Keeping the body dry improves the rider's comfort and helps maintain alertness, which can prevent accidents.

Safe Riding

▼ Tips for Safe Riding

Make sure that you are physically fit and mentally focused before riding. Do not drink alcohol or take medication before or during riding.

- Ride cautiously and keep your hands on the handlebars and feet on the footrests.
- Always pay attention to other vehicles around you, stay alert, and be prepared for emergency braking or evasive maneuvers.
- Accelerate and brake smoothly, switch on the turn signal lights before turning or changing lanes, and use your horn if necessary.
- Avoid riding while fatigued, as fatigue and inattention can impair your ability to exercise good judgement and ride safely.
- Keep your vehicle properly maintained and in good riding condition.
- The vehicle's braking performance may be reduced under wet conditions, such as slippery roads, so be sure to ride cautiously at lower speed.
- The braking distance will increase in rain or snow, so reduce speed and ride carefully. Whenever possible, avoid riding in bad weather such as heavy rain or strong wind.
- Do not ride through deep water when the water surface is higher than the center of the motor axle. Deep water may get into the motor and cause it to malfunction.

▼ If You are Involved in a Crash

Personal safety is your top priority. If you or anyone else has been injured, take time to assess the severity of the injuries and whether it is safe to continue riding.

Call for emergency assistance if necessary. Also follow local laws and regulations if another person or vehicle is involved in the crash.

If you decide to continue riding, turn off the power switch and evaluate the condition of your vehicle.

Check the power battery for damage, ensure all critical nuts and bolts are securely fastened, and inspect the handlebar, brakes and wheels. Ride slowly and cautiously.

After an accident, have your vehicle inspected and repaired by a qualified service facility as soon as possible. During transport, keep the following in mind:

- If your vehicle is extensively damaged in a crash, there may be a risk of electric shock. Do not touch any electrical components (refer to page 16) or their connecting wires.
- Avoid contact with the brake fluid. A serious crash may cause leakage of the brake fluid. Avoid contact of the brake fluid with your skin or eyes.

Safe Riding

⚠ DANGER

This vehicle uses a high-voltage lithium battery. Improper handling during an accident may result in serious injury or death.

In the event of an accident, follow the procedures and instructions described in this manual.

▶ **Power Battery**

If the power battery emits an unusual odor, there may be a malfunction. Immediately park your vehicle in a safe outdoor location and away from flammable materials, turn off the power switch, and contact after-sales service as soon as possible.

(For information on how to charge the battery, refer to page 49)

Do not attempt to disassemble or modify the battery.

▶ **Braking System**

Observe the following guidelines:

- Avoid excessive emergency braking. Sudden braking may cause tires to slip and reduce the vehicle's stability. Reduce speed before turning.
- Exercise caution on low traction surfaces. The tires slip more easily on such surfaces and braking distances are longer.
- Repeated braking, such as when descending long, steep slopes can seriously overheat the brakes, reducing their effectiveness.
- For optimal braking performance, operate both the front and rear brakes together.

Safe Riding

Accessories and Modifications

Modifications to this vehicle are strictly prohibited. Modifying your vehicle may also void your warranty and make your vehicle illegal to operate on public roads.

The user alone shall be responsible for any quality issues or consequences resulting from unauthorized modifications.

Improper accessories or modifications may cause accidents and pose a risk of serious injury or death to you and others. Follow all instructions in this manual regarding accessories and modifications.



DANGER

Loading Guidelines

This vehicle is designed for one rider only. Do not carry any additional passenger to avoid accidents.

Maximum load capacity: 100 kg.

Overloading affects your vehicle's handling, braking and stability. Avoid overloading and keep within specified load limits.

Always ride at a safe speed when carrying heavy loads. Secure the load properly on the vehicle. Make sure the load does not shift side to side while riding, and adjust it if necessary.

Do not place any items near the lights or motor.

Do not place any items near the handlebar, as they may interfere with handlebar operation.

Do not carry items that are excessively heavy or bulky.

Overloading, improper loading or carrying too many people may lead to accidents and cause serious injury or death. Follow the loading guidelines in this manual for safe loading.



DANGER



3- Vehicle Overview

3.1 Main Components

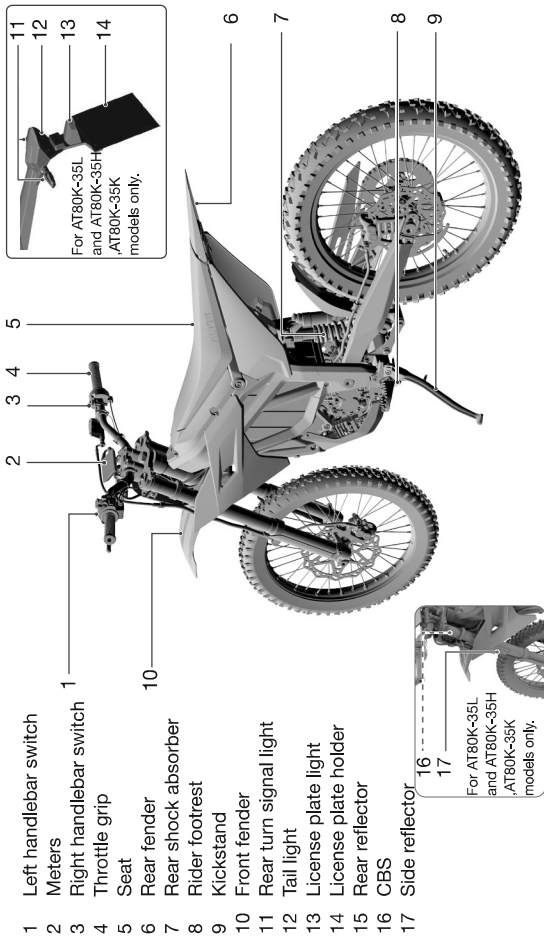

Vehicle Overview

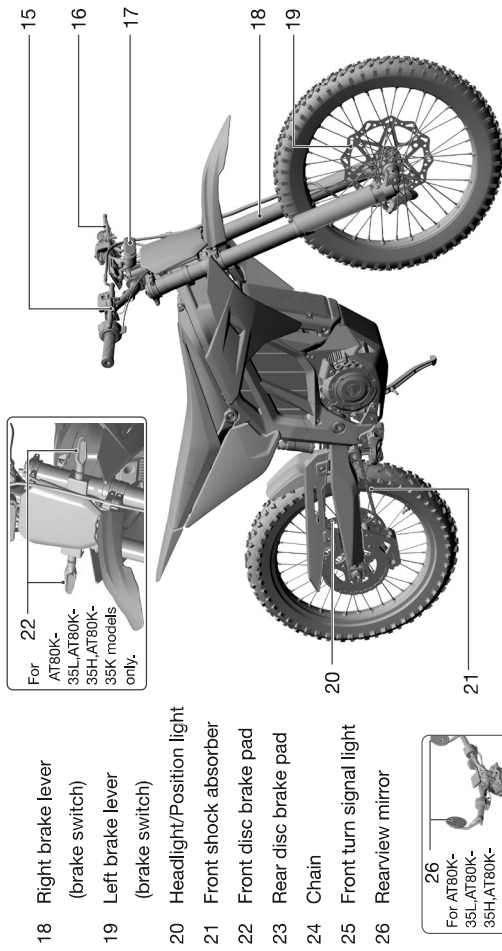

- 18 Right brake lever (brake switch)
- 19 Left brake lever (brake switch)
- 20 Headlight/Position light
- 21 Front shock absorber
- 22 Front disc brake pad
- 23 Rear disc brake pad
- 24 Chain
- 25 Front turn signal light
- 26 Rearview mirror

For 22
AT80K-
35L, AT80K-
35H, AT80K-
35K models
only.

26
For AT80K-
35L, AT80K-
35H, AT80K-
35K models
only.



Vehicle Overview

3.2 Electrical Components

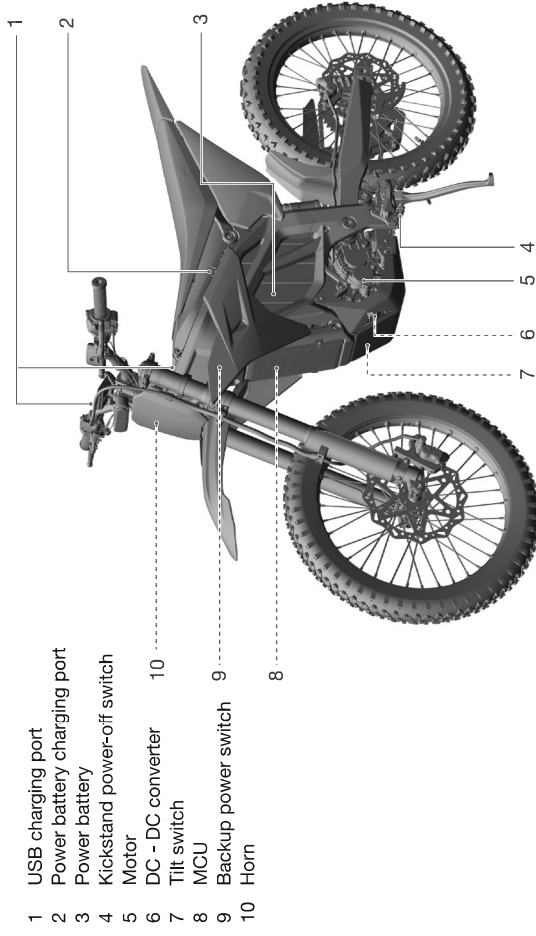

- 1 USB charging port
- 2 Power battery charging port
- 3 Power battery
- 4 Kickstand power-off switch
- 5 Motor
- 6 DC - DC converter
- 7 Tilt switch
- 8 MCU
- 9 Backup power switch
- 10 Horn

3.3 Handlebar Switches

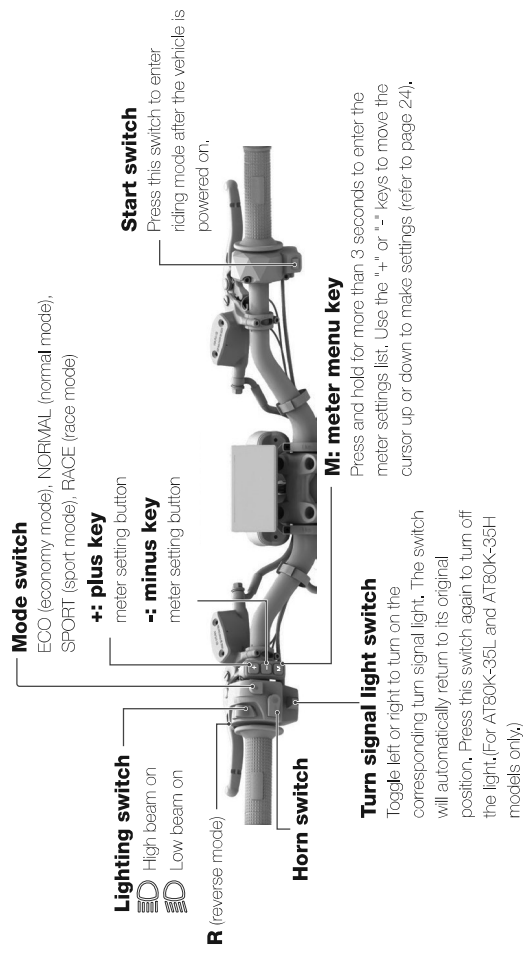

Vehicle Overview

3.4 Meters

▼ Main Screen

The main screen displays several vehicle metrics:

- Position light:** Indicated by a crossed-out lightbulb icon.
- Battery level:** A gauge showing 100% charge.
- NFC:** A gauge showing 0, with the text "(NFC)" below it.
- Mode display:** Shows "NORMAL" with left and right turn signal arrows.
- Instantaneous speed:** A large central gauge showing 50 mph.
- Instantaneous current:** A gauge showing 100 A.
- Single-trip mileage:** A gauge showing 888.8 miles.
- Total mileage:** A gauge showing 888888 miles.
- Other indicators:** Includes OBD, High beam, and Right turn signal light icons.

Instantaneous current
Instantaneous speed
 Off-road tires may jump and slip when driving at high speeds. It is normal for the displayed speed to differ from the actual GPS speed. The higher the speed, the greater the difference.

NFC
 Displayed when using the NFC card to start. (Refer to page 34)

Vehicle Overview

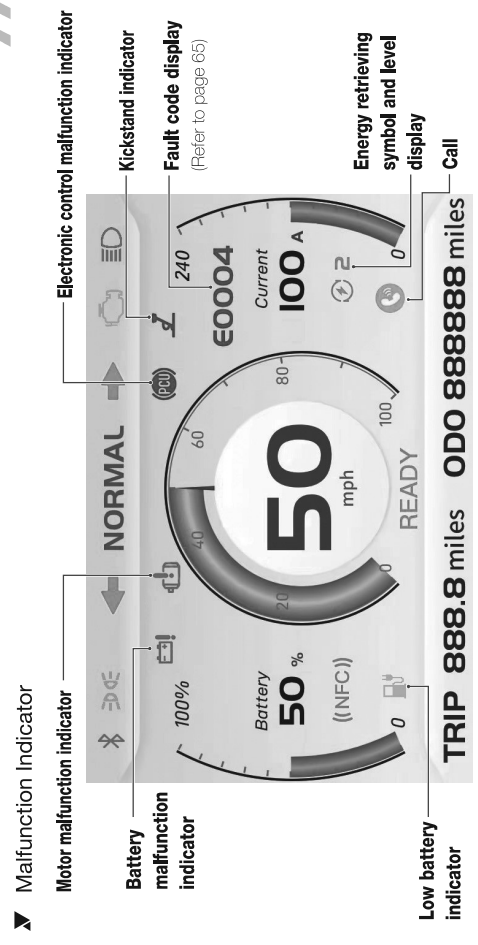

NOTICE

When the vehicle is powered on, all the indicators will briefly light up and then turn off. If any of the above indicators fails to operate as described, contact after-sales service for troubleshooting.

Vehicle Overview

3.5 NFC Cards and Spare Mechanical Keys

Your vehicle is equipped with two NFC cards (one main card (red), one secondary card (black)) and two spare mechanical keys.

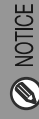

NOTICE

Always carry an NFC card or a spare mechanical key with you when using the vehicle, and store them securely after use to prevent loss. If you lose any key or NFC card, contact after-sales service.



Main card: red

Secondary card: black

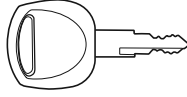

- Use of NFC Card (refer to page 41)
- Use of Spare Mechanical Key (refer to page 23)

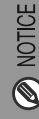

NOTICE

The NFC wireless communication system uses low-intensity radio waves. It may interfere with medical devices such as pacemakers.

Operating Range

The operating range of the NFC card is within 30 mm of the NFC reading area.

The NFC wireless communication system may not work properly under the following conditions.

- When there are facilities nearby that generate strong radio waves or noise (e.g., TV towers, power stations, broadcasting stations, or airports).
- When you carry the NFC card with other wireless communication devices, such as laptops, radios or mobile phones.
- When the NFC card comes into contact with metal or is covered by metal objects.

Precautions for Using the NFC Card

- Do not bend or press the NFC card forcefully, or place heavy items on it.
- Store the NFC card properly, away from direct sunlight, high temperatures and high humidity.
- Do not scratch or pierce the NFC card.
- Do not store it near magnetized products such as magnetized key chains.
- Always keep the NFC card away from electrical products (e.g., TVs, radios, computers or low-frequency massage devices).
- Keep the NFC card away from liquids. If it gets wet, dry it immediately with a soft cloth.
- Keep the NFC card away from the vehicle while washing the vehicle.

Vehicle Overview

- Do not burn the card,
- Do not wash the NFC card in an ultrasonic cleaner,
- If fuel, wax or grease adhere to the NFC card, wipe it off immediately.
- Do not disassemble the NFC card.
- Do not use your NFC card. If it is lost, you will need to register a new NFC card and contact after-sales service.
- Do not change the usage scenarios or conditions, expand the transmission frequency range, increase the transmission power (including adding RF power amplifiers), or modify the transmission antenna without authorization.
- Do not produce harmful interference to other legitimate radio stations, or claim protection from harmful interference.
- It must withstand interference from industrial, scientific, and medical (ISM) application equipment emitting RF energy, or from other legitimate radio stations.
- If it generates any harmful interference with other legitimate radio stations, stop using the card immediately and take measures to eliminate the interference before resuming.
- When using micro-power equipment in aircraft and electromagnetic environment protection areas, such as military and civilian radio stations, including radio astronomy observatories, weather radar stations, satellite ground stations (including measurement and control, ranging, receiving and navigation stations), and airports, which are planned and built in accordance with national laws, regulations and standards, be sure to comply with regulations related to electromagnetic environment protection and issued by relevant authorities.

- The use of any modal remote controllers is prohibited within a 5,000 m radius from the center of an airport runway.

3.6 Charging Ports

▶ Battery Charging Port

The battery charging port is located on the side of the battery as shown. Please press to open the charging port cover .

→ For precautions regarding the use of the power battery, refer to page 41.

→ For instructions on how to charge the power battery, refer to page 49.

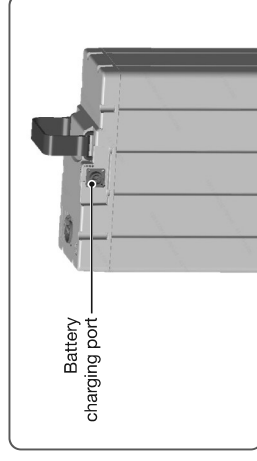

Vehicle Overview

▶ USB Charging Ports

There are two USB charging ports located on the right side of the meters and in front of the seat (see illustration). Open the covers to use.

Types of the USB charging ports:
Type-A/Type-C (5V, 1A)

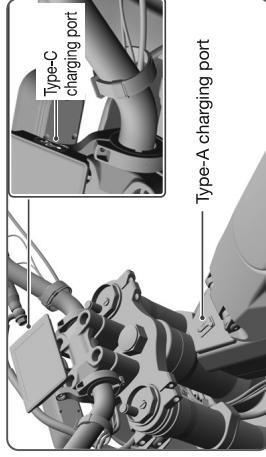

Precautions for Use

- Handle the USB charging plug carefully. Do not shake the plug side to side or up and down while inserting or removing it.
- The USB charging port provides voltage output only after the power is turned on.
- To prevent foreign matter or water from entering the USB charging port, keep the cover closed when not in use.
- To prevent any damage caused by movement or vibration during riding, place your connected devices securely.
- Disconnect all devices and charging cables, and close the cover before washing the vehicle.
- Do not operate the connected devices during riding.



NOTICE

Do not use devices that generate heat or exceed the allowable power capacity.
Do not use the charging ports when they are wet.
Make sure the charging cables of connected devices do not interfere with steering or riding.

Vehicle Overview

3.7 Kickstand Power-Off Switch

This vehicle is standardly equipped with a kickstand power-off switch. If the kickstand is not retracted, the motor will not operate, and the vehicle cannot be used.

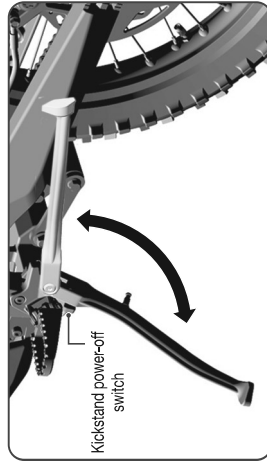

3.8 Seat

The seat lock is located under the rear of the vehicle. Press the seat lock cover to pop it open, insert the spare mechanical key, turn it clockwise to unlock, and lift the seat.

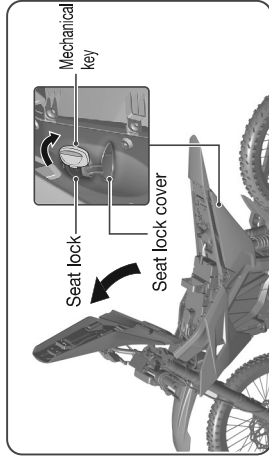

The seat locks automatically when closed. Make sure to remove the spare mechanical key and close the seat lock cover.

You can also open the seat through the settings in the meters (reserved function) (refer to page 35).

4. Operating Guidelines

4.1 Meter Settings

The meter offers Day, Night and Automatic screen theme modes, and supports both English and Spanish for user settings. Day mode and English are used for illustration in this manual.

The meter lights up when the vehicle is powered on. Confirm that the vehicle is in P mode, and then you can perform relevant operation settings.

→ For instructions on how to start the vehicle, refer to page 37.

✔ Password Setting

A verification password is required the first time you access the meter settings screen. The default password is "0000". If you want to change or reset the password, refer to page 36.

✔ Main Screen

Press and hold the "M" key for more than 3 seconds to enter the main screen settings list (as shown). Use the "+" or "-" key to move the cursor up or down, and press the "M" key to enter the corresponding menu.

Select "Exit" and press the "M" key to exit the menu.

Press and hold the "M" key to return to the previous menu.

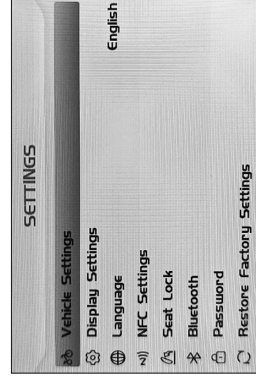

→ Vehicle Settings (refer to page 25)

→ Display Settings (refer to page 31)

→ Language (refer to page 33)

→ NFC Settings (refer to page 34)

→ Seat Lock (refer to page 35)

→ Bluetooth (refer to page 36)

→ Password (refer to page 36)

→ Restore Factory Settings (refer to page 36)

Operating Guidelines

4.1.1 Vehicle Settings

Wheel Size Setting

Navigate to the "Vehicle Settings" menu, select "Wheel Size", and press the "M" key. After password verification, enter the settings page. Use the "+" or "-" keys to move the cursor up or down and select the size from "12 inch/14 inch/16 inch/18 inch/19 inch". Press the "M" key to save settings and return to the previous menu.

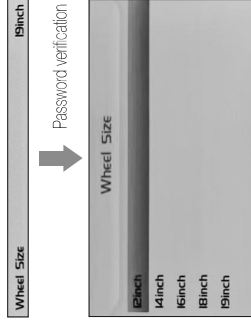

Gear Ratio Setting

Navigate to the "Vehicle Settings" menu, select "Gear Ratio", and press the "M" key. After password verification, enter the settings page. Use the "+" or "-" keys to move the cursor up or down and select the value from "6.9/7.4/8.3/9.1/10/11". Press the "M" key to save settings and return to the previous menu.

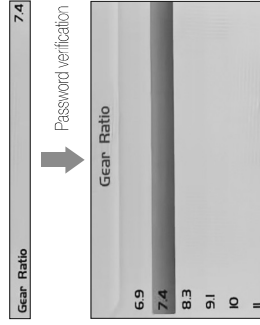

Operating Guidelines

Throttle Setting

Navigate to the "Vehicle Settings" menu, select "Throttle Mode", and press the "M" key. After password verification, enter the settings page. Use the "+" or "-" keys to move the cursor up or down and select from the three modes of "Weak/Medium/Strong". Press the "M" key to save settings and return to the previous menu.

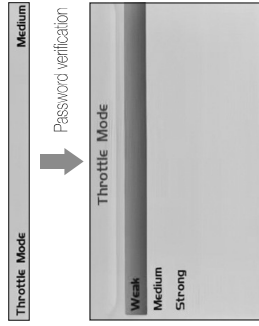

Torque Limit

Navigate to the "Vehicle Settings" menu, select "Torque Limit", and press the "M" key. After password verification, enter the settings page. Use the "+" or "-" keys to move the cursor up or down and select the setting from "60%/80%/100%". Press the "M" key to save settings and return to the previous menu.

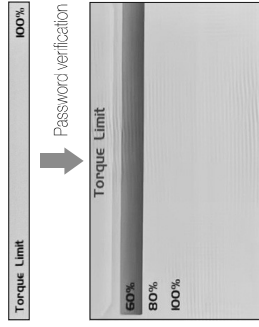

Operating Guidelines

Energy Retrieving

Navigate to the "Vehicle Settings" menu, select "Energy Retrieving", and press the "M" key. Use the "+" or "-" keys to move the cursor up or down and select the energy retrieving level from "0/1/2/3/4". Press the "M" key to save settings and return to the previous menu.

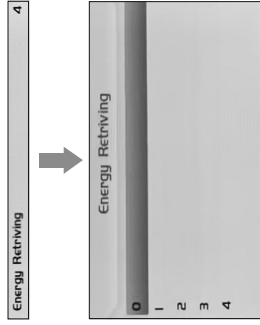

This can also be set on the main screen using "+" or "-" keys on the meter.

Kickstand Switch Enable Control

Navigate to the "Vehicle Settings" menu, select "Kickstand Sensor", and press the "M" key. After password verification, enter the settings page. Use the "+" or "-" keys to move the cursor up or down and select "On" to enable or "Off" to disable. Press the "M" key to save settings and return to the previous menu.

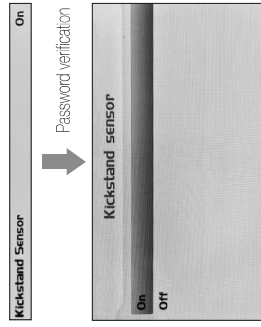

Operating Guidelines

▶ Tilt Enable Control

Navigate to the "Vehicle Settings" menu, select "Tilt Sensor", and press the "M" key. After password verification, enter the settings page. Use the "+" or "-" keys to move the cursor up or down and select "On" to enable or "Off" to disable. Press the "M" key to save settings and return to the previous menu.

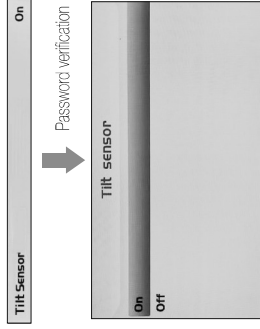

▶ Brake Power-Off Enable Control

Navigate to the "Vehicle Settings" menu, select "Brake Power-off", and press the "M" key. After password verification, enter the settings page. Use the "+" or "-" keys to move the cursor up or down and select "On" to enable or "Off" to disable. Press the "M" key to save settings and return to the previous menu.

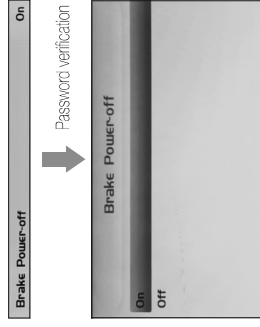

Operating Guidelines

A risk alert and confirmation screen will appear after the setting, so be sure to read it carefully.

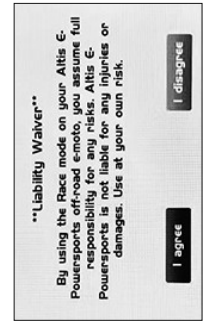

- RACE Gear Enable Control**
 Navigate to the "Vehicle Settings" menu, select "RACE Gear", and press the "M" key. After password verification, enter the settings page. Use the "+" or "-" keys to move the cursor up or down and select "On" to enable or "Off" to disable. Press the "M" key to save settings and return to the previous menu.

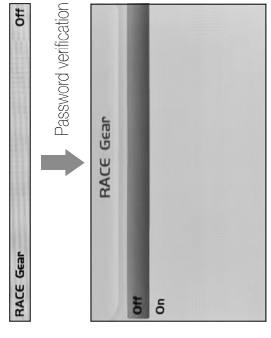

NOTICE
 This settings page can be accessed only with the NFC main card (red).



Operating Guidelines

▶ Riding Information

Navigate to the "Vehicle Settings" menu, select "My Vehicle", and press the "M" key to enter the vehicle information display page. The information displayed includes:

- Avg Speed: average speed
- Max Speed: maximum speed
- Run Time: riding time
- Battery Cycles: battery cycle count
- Motor Temperature: temperature of motor
- Controller Temperature: temperature of controller
- Battery Max Temperature: highest battery temperature
- Battery Min Temperature: lowest battery temperature

Press "EXIT" to return to the previous menu.

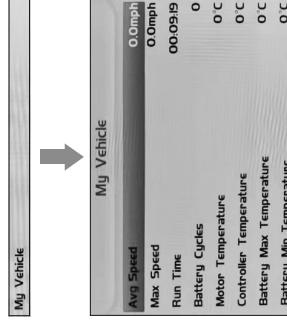

Operating Guidelines

4.1.2 Display Settings

Screen Theme settings

Navigate to the "Display Settings" menu, select "Screen", and press the "M" key to enter the settings page. Use the "+" or "-" keys to move the cursor up or down and select from "Day/Night/Auto". Press the "M" key to save settings and return to the previous menu.

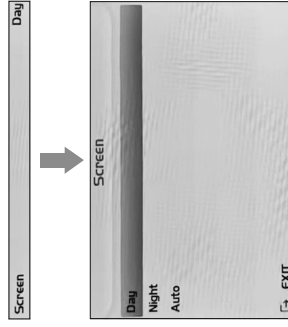

Screen Brightness Adjustment

Navigate to the "Display Settings" menu, use the "+" or "-" key to move the cursor up or down and select "Brightness". Press the "M" key to enter the settings page and select from "25%/50%/75%/100%". Press the "M" key to confirm settings and return to the previous menu.

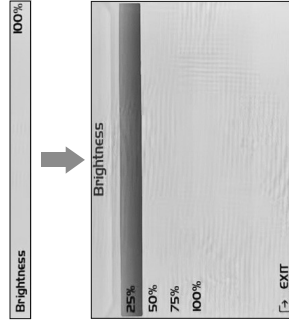

Operating Guidelines

- Conversion Between Imperial and Metric Units**
 Navigate to the "Display Settings" menu, select "Unit", and press the "M" key to enter the settings page. Use the "+", "-" or "." keys to move the cursor up or down and select from "kph/mpH". Press the "M" key to save settings and return to the previous menu.

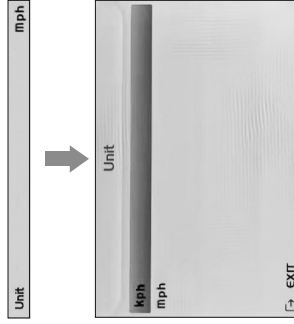

- Riding Information**
 Navigate to the "Display Settings" menu, select "Driving Information", and press the "M" key to enter the settings page. Use the "+", "-" or "." keys to move the cursor up or down and select the display mode from "TRIP ODO/MAX AVE/TIME POWER". Press the "M" key to save settings and return to the previous menu.

TRIP ODO: Mileage of this trip and total mileage
 MAX AVE: Maximum speed and average speed
 TIME POWER: Riding time and instantaneous current

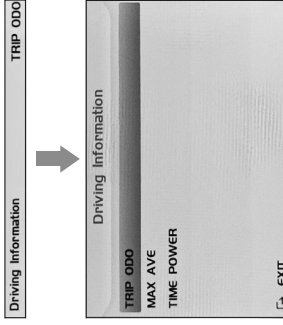

Operating Guidelines

▼ Meter information

Navigate to the "Display Settings" menu, select "Display Information", and press the "M" key to enter the meter information menu. The version of the current meter firmware will be displayed.

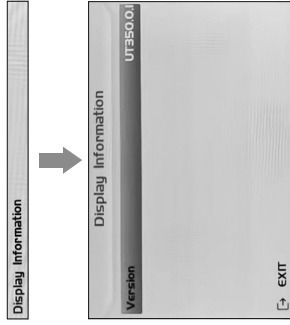

4.1.3 Language Selection

The meter is available in English and Spanish for users to choose from. Press and hold the "M" key to access the settings page. Use the "+" or "-" keys to move the cursor up or down and select "Language". Press the "M" key to enter the language selection screen, move the cursor to switch between "English" and "Spanish", and press the "M" key to confirm settings and return to the previous menu.

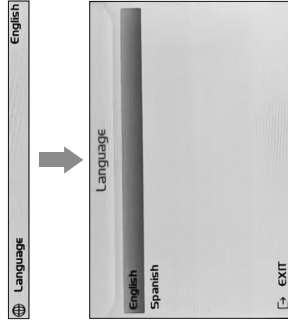

Operating Guidelines

4.1.4 NFC Settings

Navigate to the "Display Settings" menu, select "NFC Settings", and press the "M" key to enter the NFC registration list. "MASTER ID" represents the main card ID, and "USER ID" represents the secondary card ID. The default value is "00:00:00:00" when no card is registered.

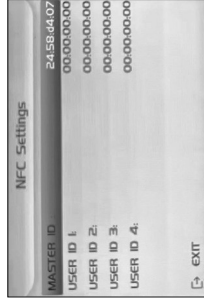

Select a card and press the "M" key to access the registration and deregistration page.



NFC Registration

Navigate to the registration and deregistration page for NFC card information, select "Registration" and press the "M" key. A prompt window will appear asking you to place the NFC card near the left side of the meter (refer to page 41). Upon successful identification, the display will return to the previous screen and the NFC card information will be shown.

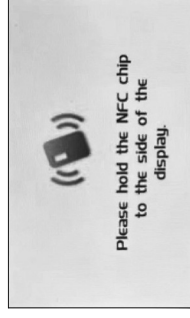

Operating Guidelines

▼ NFC Deregistration

Navigate to the registration and deregistration page for NFC card information, select "Delete" and press the "M" key. The NFC card information will be deleted, the display will return to the previous screen, and the NFC card list will be shown.

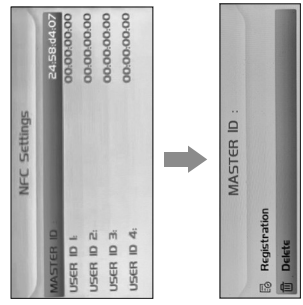

4.1.5 Seat Lock Control (Reserved Function)

The meter supports seat lock control. Press and hold the "M" key to enter the settings list, select "Seat Lock" and press the "M" key to unlock the seat.

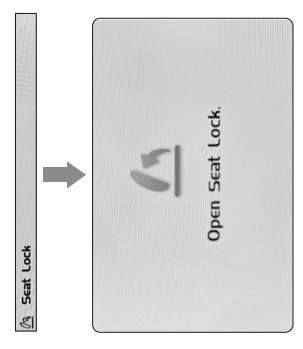

Operating Guidelines

4.1.6 Bluetooth Connection

Press and hold the "M" key to access the settings information list. Use the "+", "-", or "." keys to move the cursor up or down, select "Bluetooth" and press the "M" key to enter the Bluetooth QR code screen. You can use the smartphone app to scan the code. In the smartphone's Bluetooth pairing screen, enter the pairing code ("88" + power-on password). The default pairing code is "880000". Once the device is successfully registered, the display will automatically return to the main screen, and the Bluetooth icon will light up.

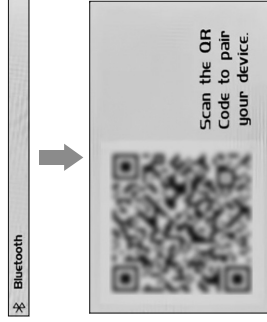

NOTICE

For Bluetooth connection, the distance between the meter and the smartphone should be under 10 m.

4.1.7 Password Setting

The default meter password is "0000". If you forget the password, you may reset it here. Press and hold the "M" key to access the system settings. Use the "+", "-", or "." keys to move the cursor up or down, select "Password" and press the "M" key to enter the password reset screen.

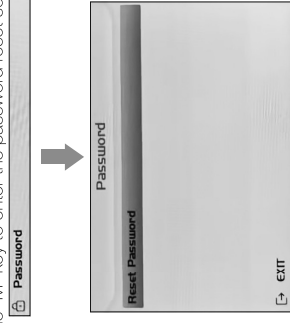

NOTICE

This settings page can be accessed only with the NFC main card (red).

Operating Guidelines

Select "Reset Password" and press the "M" key to display the NFC main card (red) authentication window. Place the NFC main card (red) near the left side of the meter for authentication (refer to page 41).

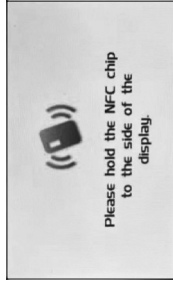

After the NFC main card (red) is authenticated, you will be prompted to "Enter your Password". Use the "+" or "-" keys to toggle between the numbers "0-9", and press the "M" key to switch digits. Once you've finished, you will be prompted to "Confirm your Password". Again, use the "+" or "-" keys to toggle between the numbers "0-9", and press the "M" key to switch digits. Finally, press the "M" key to successfully reset the password.



4.1.8 Restore Factory Settings

Press and hold the "M" key to access the settings information list. Use the "+" or "-" keys to move the cursor up or down, select "Restore Factory Settings", and press the "M" key to enter the confirmation screen. Press "Confirm", and the meters will automatically restart to restore the factory settings. Then press "EXT" and return to the previous screen.





Operating Guidelines

4.2 Bluetooth Function

✔ Initial Pairing

After the meter is powered on, enter the main screen to start the Bluetooth connection with your smartphone. On your smartphone's Bluetooth device list, select the device with the prefix "TL-HIK" and enter the Bluetooth pairing code ("88" + power-on password).

Once the pairing code is entered, the Bluetooth connection will be established. Upon successful connection, the Bluetooth indicator on the main screen will light up (refer to page 18).

✔ Incoming Call Notification

When the smartphone is connected via Bluetooth, incoming call notifications can be displayed on the meter (refer to page 18).

4.3 OTA Update

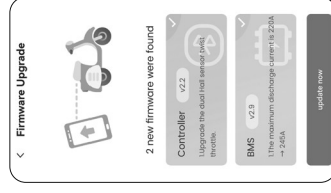
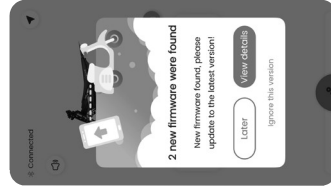

After the meter is powered on, it needs to connect with the smartphone app. Once the connection is established, the OTA upgrade operation will be confirmed and initiated with the smartphone app.

Select "View details" in the smartphone app to review the pushed new software information.

Operating Guidelines

Note: If the above window does not pop up, you can navigate to the "Bike Settings" menu, then select "Firmware Upgrade" in the app to view the details.

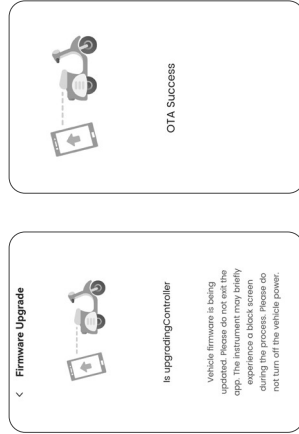
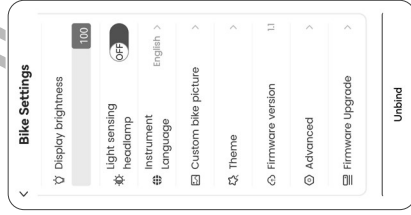

Select and confirm the latest version of the software to be upgraded on the "Firmware Upgrade" page. The upgrade procedure will be executed automatically after confirmation. It is normal that the meter may display a black screen during the upgrade.

After the upgrade is completed, the meter will automatically jump to the main interface, and the upgrade operation will be fully completed by then.



5. Riding Guidelines

5.1 Pre-Ride Check

Check the following items every time before you ride your vehicle to ensure that it is in safe working condition.

Always follow the check items, maintenance procedures, and maintenance schedule specified in this manual (refer to page 18).

Battery level	Check the remaining level of the power battery, and recharge it if necessary.	Page 18
Meter	Check for any damage or dirt, and see if any malfunction indicators appear when the meter lights up.	Page 19
Lights	Check if all the vehicle lights are functioning properly.	Page 14-15
Handlebar	Check if it operates smoothly in all steering positions.	--
Brake levers	Check if the braking operates smoothly.	Page 43
Front and rear brakes	Check the brake fluid level and brake pad wear.	Page 57-58

Tires	Check the tire condition and tread. Inflate or deflate if necessary.	Page 54
Kickstand switch	Check if it is fully functional.	Page 59

Riding Guidelines

5.2.1 Starting the Vehicle using the NFC Card

Place the NFC card near the NFC reading area on the left side of the meter. When the vehicle receives the NFC unlock signal, the power will be turned on.

Retract the kickstand and press the "Start" switch (or lightly squeeze the brake lever$>0.8S$) to release the parking state and enter the riding state.

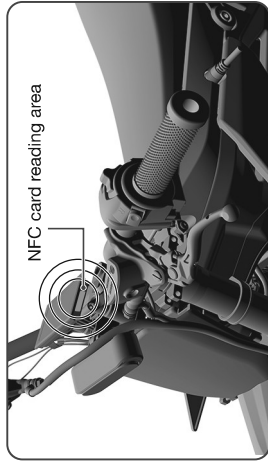

For instructions on how to turn off the power, refer to page 44.

5.2 Starting the Vehicle

There are two ways to start your vehicle, as shown below.

If the vehicle is powered on but not used for an extended period, it will enter the parking state. Press the "Start" switch to restore power.

If the Brake Power-off function is disabled in the meter settings (refer to page 28), the parking function will also be disabled by lightly squeezing the brake lever.

If the vehicle has not been used for more than 8 days, the meter will enter low-power mode. To start the vehicle with the NFC card, briefly press the "M", "+", or "-" key once.

If the vehicle has not been used for more than 30 days, the battery will enter low-power mode. The NFC card start functions will be unavailable. You must use the backup power to start the vehicle; Alternatively, press the battery indicator button or charge the battery to activate it. Then, before using the NFC card to start the vehicle, briefly press the "M", "+", or "-" key once.



NOTICE

- Start the Vehicle Using the NFC Card (refer to page 41)
- Start the Vehicle Using the Backup Power (refer to page 42)

Riding Guidelines

5.2.2 Starting the Vehicle Using Backup Power

The backup power switch is located under the seat. Open the seat (refer to page 23) and press the backup power switch to power on the vehicle.

Retract the kickstand and press the "Start" switch (or lightly squeeze the brake lever >0.8S) to release the parking state and enter the riding state.

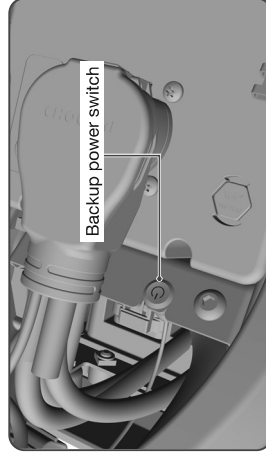

If the vehicle is started using the backup power, the power to the vehicle can only be turned off by switching off the backup power switch.

For instructions on how to turn off the power, refer to page 44.

5.2.3 Start the vehicle Using the APP

After connecting the Bluetooth of the vehicle (refer to page 38), press the "M" key and Slide "Slide to Start" in the APP to power on the entire vehicle.

Retract the kickstand and press the "Start" switch (or lightly squeeze the brake lever) to release the parking state and enter the riding state.

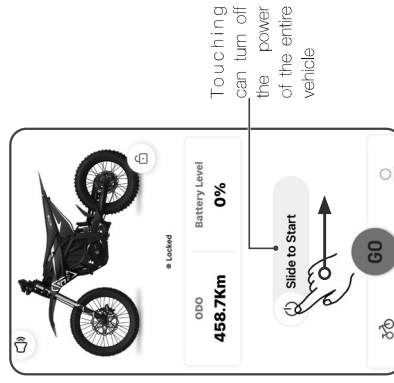

Riding Guidelines

5.3 Riding

Before starting, check the traffic around you and use the turn signal lights to indicate your intended direction.

Make sure that the surrounding conditions are safe for riding, then slowly rotate the throttle grip to set off.

Acceleration: Turn the throttle grip in direction (a).

Deceleration: Turn the throttle grip in direction (b).

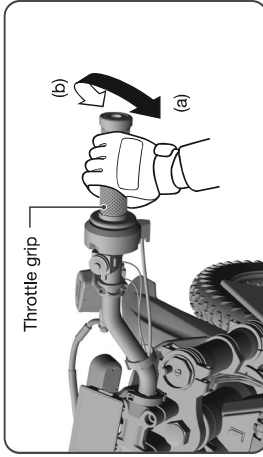

Do not turn the throttle grip rapidly to avoid sudden acceleration, which may result in an accident.

5.4 Braking

When approaching a turn or coming to a stop, reduce speed and begin braking in advance.

Switch on the turn signal lights in advance and be mindful of vehicles and pedestrians around you. Return the throttle grip to its initial position, and then squeeze the brake levers, first slowly then gradually faster.

When operating the front/rear brake lever, the brake switch will be automatically turned on, cutting off the motor's power output.

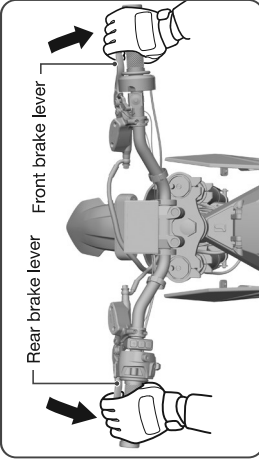

Riding Guidelines

Avoid excessive force or emergency braking (especially when the vehicle is leaning to make a turn), as this may cause slipping or turn over. Braking on wet roads may cause slipping and result in danger: reduce speed and ride cautiously. Repeated braking, such as when descending long, steep slopes can seriously overheat the brakes, reducing their effectiveness. For safety, operate both front and rear brakes together, and use the brakes intermittently to reduce speed.



WARNING

5.5 Parking

Park the vehicle on a solid, flat surface using the kickstand. If you must park on a slight incline or loose surface, ensure that the vehicle is stable, and prevent it from moving or tipping over.

1 Turn off the vehicle.

There are two ways to turn off the vehicle.

- NFC card: When the vehicle is in standby mode, place the NFC card near the reading area on the left side of the meter to turn off the power.
- Backup power switch: Turn off the backup power switch, and the meter will automatically shut off.

2 Lower the kickstand and gently lean the vehicle to the left until its weight is rests on the kickstand.

3 Turn the handlebar all the way to the left. After confirming that your surroundings are safe, get off the vehicle from the left side.

Do not park the vehicle in a location that could obstruct traffic.

Make sure that the power is turned off before leaving the vehicle. Carry the NFC card or spare mechanical key with you to prevent others from operating the vehicle.



NOTICE

5.6 Push Assistance

After the vehicle is shifted out of P gear, press and hold the Mode button for at least 3 seconds to enter the push assistance mode; shifting the vehicle into P gear or pressing and holding the Mode button for at least 3 seconds can exit this mode. After entering the push assistance mode, the meter will display a prompt pop-up as shown in the figure below.

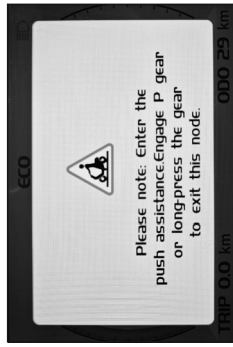



6. Battery and Charging

6.1 Power Battery

This model is equipped with a power battery, which is located at the center of the frame (refer to page 16).



WARNING
Do not attempt to disassemble or modify the power battery.

With repeated charging and discharging, the battery capacity will decrease.

When the battery capacity decreases, the distance that you can ride will gradually decrease, even if the power level displayed is full (fully charged).

The discharging performance will gradually decline depending on your riding conditions and the vehicle life.

The vehicle's mileage may decrease when operated in extreme hot or cold conditions.

If the vehicle will be stored for an extended period, use the official charger to charge the battery every three months, keeping the battery level between 40% and 60%.

If the battery is completely discharged due to prolonged storage and the vehicle cannot be started, connect the charger to recharge the battery for at least 30 minutes before trying to start the vehicle again.

Do not wait until the battery is fully discharged before charging. It may greatly affect the battery life.



DANGER

Improper use of the power battery may result in electric shock or fire, which may lead to serious injury or death.
Do not attempt to disassemble the used battery. It should be recycled and handled by a professional recycling service.



NOTICE

The discharge capacity of lithium batteries will weaken in low-temperature conditions (< 10°C), and the output power of the entire vehicle will decrease. During use, as the battery temperature rises, the discharge capacity will gradually increase.

Battery and Charging

6.2 Battery Installation and Removal

This model uses a high-voltage lithium battery. Follow the relevant safety precautions and proceed with the steps below.

Contact after-sales service if you have any questions during the installation and removal process.

▶ Battery Removal

- 1 **Make sure the vehicle is completely powered off.**
For instructions on how to turn off the vehicle, refer to page 44.
- 2 **Open the seat (refer to page 23).**
- 3 **Remove the battery connection plug.**
- 4 **Loosen the locking clip, rotate the battery pressure plate 90° clockwise, and then remove the battery by holding the battery handle.**

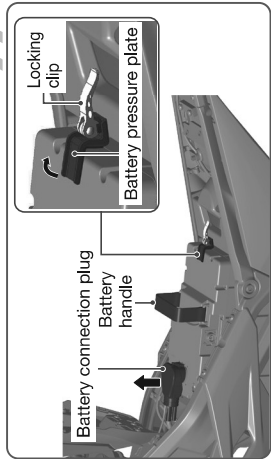

▶ Battery Installation

Install the battery in the reverse order, connect the plug and close the seat.

Turn on the vehicle's power and check if the electrical system is functioning properly (refer to page 40).

AA

Battery and Charging

6.3 Charger

Store the power battery charger in a place away from direct sunlight and rain.

During charging, you can check the battery's charging status through the indicator lights on the charger.

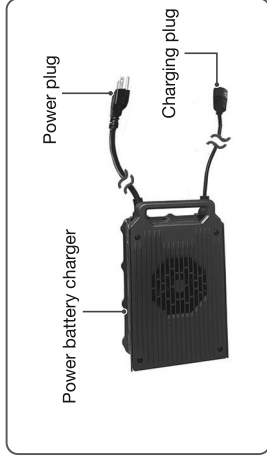

Charger Indicator Lights

No load indicator	Green LED Flickering
Slow Charge	Red LED Flickering
Normal Charge	Red LED constant ON
Fully charged	Green LED constant ON
Low battery voltage	Red LED flicker 4 times Green LED flicker 1 time
Battery overvoltage	Red LED flicker 4 times Green LED flicker 1 time
Reverse Polarity	Red and Green LED flickering alternately
Short circuit	Red and Green LED flicker at the same time
Malfunction indicator	

WARNING

If the charger or battery malfunctions, stop charging immediately and take the vehicle and charger to after-sales service for inspection, repair, or replacement of parts.

Battery and Charging

6.4 How to Charge

⚠ Charging Environment

Charge the vehicle in a well-ventilated, dry and shaded place where it is legally allowed.

Ambient temperature: 0°C (32°F) - 45°C (113°F) . .

Never charge the battery in a damp or dewy location, or in areas with flammable or explosive materials, volatile flammable gases, or excessive dust. Do not allow non-professionals to disassemble the internal structure of the battery to prevent accidents.



⚠ Charging Method

Always use the battery charger provided with this vehicle to charge the power battery.

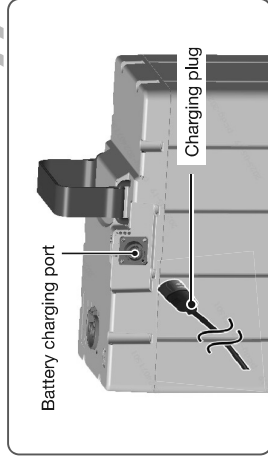

When charging, the battery must be in a stable state. Connect the charger to the battery port and then to a household socket.

⚠ Charging Time

Charging a fully discharged power battery takes about 3 - 4 hours. The charging time may be longer at higher or lower ambient temperatures. Do not charge for more than 12 hours to prevent reducing the battery's service life.



Battery and Charging

▼ Precautions for Charging

- When charging, please insert the battery end first, then the power plug. If there is a "pop" sound, it is normal.
- When stopping charging, please unplug the power plug first, then unplug the battery end plug.
- The charger is dedicated to this vehicle and should not be used for other vehicles to avoid damage.
- The charger outputs direct current (DC), indicated by "+" and "-" polarities. Ensure the correct polarity when connecting.
- The charger must not be immersed in water. If the plug or charger has been immersed in water, stop using it immediately.
- Keep the charger away from explosive gases and avoid flames or sparks while in use.
- The charger generates heat while operating. Make sure it has proper ventilation and avoid placing it on sofas or other flammable objects.
- The output voltage of the charger exceeds DC 42 V. Use it in a safe manner, and do not open the charger if you are not a professional to avoid electric shocks or failures.
- The charger is fan-cooled and may produce some noise (sound of airflow from the rotating fan blades), which is not a malfunction.
- If the charger or power outlet is damaged or deformed, or the power cord is frayed, stop using and have it replaced by a professional.
- Do not charge the battery while it is covered. Make sure there is proper ventilation around the battery.
- Do not charge in places where there is risk of lightning.
- Do not overload a power outlet with too many power cords.
- Do not plug or unplug the charger by pulling the cable.
- Do not repeatedly charge the battery after it is fully charged.
- Read this manual carefully before use. If there are any abnormalities with the indicator lights or the charger casing is overheating, stop charging immediately and have it inspected by a professional.
- If the power supply is damaged or the charging system malfunctions, take the vehicle to after-sales service center for repair or replacement.

Battery and Charging

In the event of a fire involving the vehicle or battery, follow these guidelines:

- If smoke is emitted from the power battery, move away from the vehicle immediately, contact the fire department, and prepare to extinguish any fire.
- Use an ABC dry powder extinguisher or an electrical fire extinguisher to put out the fire. If the fire is out of control, contact the fire department.
- After extinguishing the fire, contact after-sales service to handle the disposal of the battery. Do not attempt to handle it.
- Depending on the location of the fire, the vehicle's power may still be on. Make sure to cut off the power after extinguishing the fire.



WARNING

7. Maintenance

Keeping your vehicle in good condition is crucial for your safety, the safety of properties, and the prevention of accidents.

It is the owner's responsibility to perform maintenance. Be sure to inspect your vehicle before each ride and perform the periodic checks specified in the maintenance schedule.

WARNING

Riding the vehicle without proper maintenance or proper troubleshooting may result in serious accidents, leading to injury or death. Be sure to follow the inspection and maintenance recommendations provided in this manual.

7.1 Maintenance Schedule

Initial Maintenance

Items	Mileage/km	Time/h	Remarks
Motor			
Motor oil change	600	-	
Electrical			
Electrical functions	600	-	
Fuses	600	-	Inspect
Braking			
Brake discs	600	-	
Brake pads	600	-	Inspect
Brake fluid	600	-	
Brake fluid lines	600	-	Check for damaged surfaces or crushed lines, and proper sealing.
Wheels			
Tire condition	600	-	
Tire pressure	600	-	Inspect
Suspension			
Front shock absorber	600	-	
Rear shock absorber	600	-	Check for oil leaks
Steering			
Steering bearing	600	-	Inspect
Others			
Bolts and nuts	600	-	Check for looseness
All moving parts	600	-	Check for proper operation and adequate lubrication

Maintenance

Periodic maintenance (perform maintenance for items that reach interval first)

Items	Mileage/Km	Time/M	Remarks
Electrical			
Electrical equipment	1000	6	Inspect; reduce the interval by 50% after two years
Fuses	5000	12	Check for leakage or detachment from mounting positions; reduce the interval by 50% after two years
Cables	5000	12	
Wheels			
Tire condition	1000	6	Inspect; if you have driven aggressively/before, you need to check before each use.
Tire pressure	1000	6	
Spoke	1000	6	
Wheel bearings	2000	12	Inspect
Braking			
Front and rear brake systems	1000	6	
Brake discs	1000	6	
Brake pads	1000	6	Inspect
Brake fluid	1000	6	
Brake lines	1000	6	
Brake fluid level	1000	6	
Motor			
Motor gear oil change	3000	-	Check if the breather valve is clogged by foreign matter. Check the gear oil level and redensify if necessary.
	5000	-	Replace gear oil

Items	Mileage/Km	Time/M	Remarks
Suspension			
Suspension system	2000	12	Inspect
Rear shock absorber	1000	6	Check for oil leaks and service the shock absorber if necessary
Front shock absorber	2000	12	
Frame			
Frame	2000	12	Inspect
Steering			
Steering bearing	2000	12	Inspect
Drive train			
Chain	500	-	Inspect and clean. Adjust, lubricate or replace if necessary.
Motor sprocket	8000	-	Replace chain
Rear sprocket	5000	-	Inspect
Others			
All moving parts	2000	12	Check for proper operation and adequate lubrication.
Bolts and nuts	2000	12	Check for looseness



Maintenance

7.2 Motor, Controller

The controller of the electric motorcycle is a key component of the vehicle that controls the motor's start, operation and other functions.

Follow the rules below:

- Do not modify the motor by yourself, doing so can easily lead to fire or accidents.
- Do not ride the vehicle in deep water, and do not allow the water level to exceed the height of the rear wheel axle.
- Frequently check the motor's fastening condition. If any screws are found to be loose, have them tightened by a service technician immediately.



If your vehicle has been parked for a long time in the rain without protection, inspect the controller and motor for any signs of water ingress before riding. If water is found in the controller or motor, it is recommended that you do not use the vehicle for some time until the water has disappeared.

7.3 Gear Oil

Reducer gear oil capacity: 0.1 - 0.12 L (0.027-0.032gal)

Fill with GL-5 75W/90 gear oil when the temperature is below -10°C(50°F);

Fill with GL-5 85W/90 gear oil when the temperature is above -10°C(50°F).

7.4 Tires

To operate your vehicle safely, select the correct type and size of tires, and make sure the tires are in good working condition with adequate tread depth and proper tire pressure.



WARNING

Using excessively worn or incorrectly pressurized tires can lead to accidents, resulting in serious injury or even death. Follow the tire pressure and maintenance instructions provided in this manual.

Checking the Tire Pressure

Check the tire pressure with a gauge at least once a month, or whenever you feel the air pressure is low, while the tires are cold. Adjust the tire pressure according to your weight and the road conditions.

Maximum front tire pressure (cold): 225 kPa
Maximum rear tire pressure (cold): 225 kPa

Overinflated tires will give you a bumpy ride, are often damaged by poor road conditions and may lead to uneven tire wear. Make sure that the valve cap is securely tightened. If necessary, replace the valve cap with a new one.

Visually Inspect of Tires

Checking for Damage

Check the tire for cuts, cracks, exposed fabric or tire cords, or nails or other foreign matter stuck in the sidewalls or tread. Also check the tire sidewalls for any bulges or swelling.

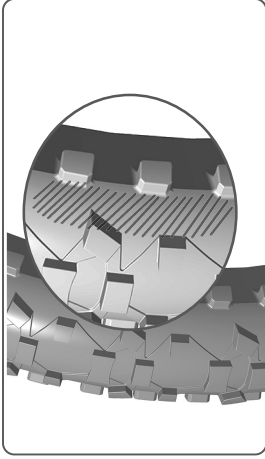

Maintenance

Checking Tread Depth

Check the tread wear indicators.

If they become visible, replace the tires immediately.

Minimum tread depth: 2 mm

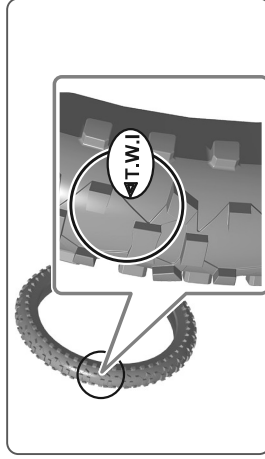

WARNING

Riding with severely worn tires will reduce the riding performance of the vehicle and may cause accidents.

▼ Tire Replacement

If the inner tube of a tire is punctured or damaged, you should have it replaced as soon as possible. Repaired tires, which do not perform as well as new ones, may rupture during riding. If you have to use a patched inner tube or use sealant to temporarily repair the inner tube, ride at a lower speed and with caution. Replace the tire before your next ride.

Follow the rules below:

- Use the recommended tires or their equivalents of the same size, construction, speed rating, and load range.
- Do not overload. Riding with an overloaded vehicle may cause accidents.
- All wheels and brake-related parts (including tires) should be replaced by a technician with professional skills and experience.



WARNING

Installing improper tires may affect the handling and stability of the vehicle, leading to accidents and causing serious injury or even death. Always use the size and type of tires recommended in this manual. (Refer to page 72)

Maintenance

7.5 Brake Fluid

Turn the handlebar. When the brake fluid level is flush with the marked line, check if the fluid level is above the lower level mark.

If the brake fluid level in the reservoir is below the lower level mark, have the vehicle inspected by after-sales service.

Recommended brake fluid grade: DOT3



NOTICE

Brake fluid can damage plastic and painted surfaces. If any fluid spills over, wipe it off immediately and clean thoroughly.

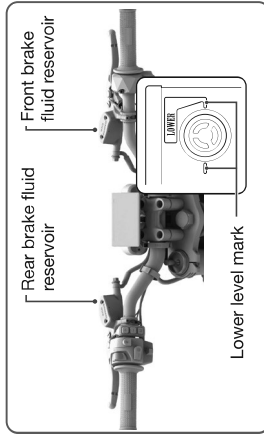

Maintenance

7.6 Brake Pads and Brake Discs

Check the condition of the wear indicators on the front and rear brake pads.

If the brake pads are worn to the bottom of the wear indicators, the pads need to be replaced.

Brake pad wear limit: 2.5 mm

Check the wear condition of the front and rear brake discs. If the brake discs are worn to the thickness specified by the manufacturer, the discs need to be replaced.

Brake disc wear limit: 2.5 mm



WARNING

Failure to replace the brake discs in time may result in extended braking distance or brake failure, which may cause accidents or injury.

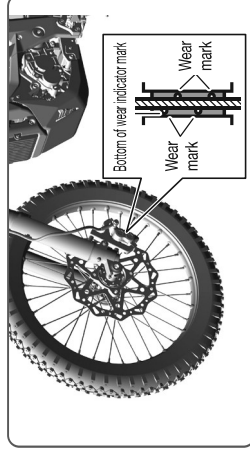

Maintenance

7.7 Kickstand

Check that the kickstand operates smoothly. If the kickstand is stiff or makes abnormal noise, clean the pivot area and lubricate the pivot bolt with clean grease.

Check the spring for damage or loss of tension.

Check the kickstand for deformation or crack, if any, contact after-sales service for repair in time.

7.8 Throttle Grip

With the power turned off, check that the throttle grip can be rotated smoothly between the fully-closed and fully-open positions, and returns automatically without being stuck.

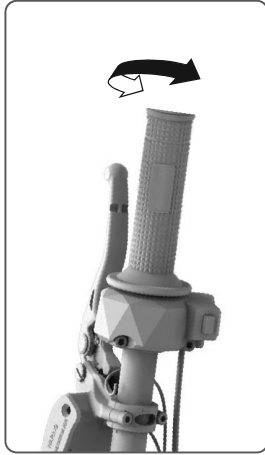

Maintenance

7.9 Chain, Spoke

Check and adjust the chain tension. Loosen the rear axle nut and adjust the chain slack by loosening or tightening the adjusting nut. While adjusting the chain, keep the front and rear sprockets aligned to prevent chain wear caused by improper adjustment. After adjustment, re-tighten the rear axle nut and tighten the screw fastening nut.

Standard chain slack: 10 - 15 mm



WARNING

A chain that is too slack or too tight can cause chain slip or breakage, posing a safety risk. Have the chain inspected and adjusted regularly at an authorized service center.

Chain Specifications

- AT80K-35/AT80K-35L/AT80K-35H: 520H/94L
- AT80K-35X/AT80K-35K: 520H/96L

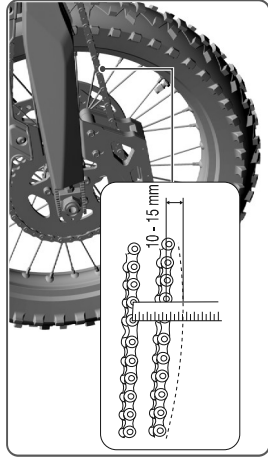

Spoke torque

Standard torque of spokes: 1.5-4.5 N.m
Loose spokes can cause the hub to wobble or rock, and continued driving can damage the hub. In aggressive driving situations, it is necessary to check for loose spokes before each trip.

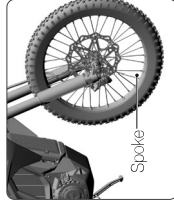

WARNING
Loose spokes will cause the wheel hub to lose support, and continuing to drive will threaten your personal safety. Please keep checking and adjusting the spokes as necessary.

Maintenance





8. Troubleshooting

8.1 Troubleshooting of Common Malfunctions

Component	Symptom of Malfunction	Solution
Luminaire	Malfunction of the luminaire	Check if the wiring plug is loose. If the problem continues, please contact after-sales service.
Kickstand power-off	The side stand power-off function is working abnormally.	Adjust the gap between the side stand power-off component and the frame. When the side stand is lowered, adjust the gap between the screw and the frame to 3-5mm. If the problem continues, please contact after-sales service.
	After reading the NFC card, the bottom screen of the meter lights up faintly (or remains very dim), accompanied by one beep; the whole vehicle can run normally; the headlight or horn can work normally.	Check if the meter plug is loose. If the problem continues, please contact after-sales service.
Meter	The meter screen flickers on and off during riding.	
	The meter restart repeatedly during riding.	
	NFC cannot be read. The vehicle can be powered on with backup power switch with the meter screen off.	① Check if the plug is loose. ② Unplug and re-plug the battery connector, then power on and use the app to update the meter version. If the problem continues, please contact after-sales service.
	The energy retrieval cannot be activated or automatically turns off after activation.	When the SOC is above 96%, the energy retrieval is disabled to prevent overcharging of the battery.
	The vehicle can be powered on but cannot be powered off via the Bluetooth through the app.	① To power on the vehicle via the Bluetooth through the app, first press the M switch on the meter briefly once, then slide the power-on switch in the app. ② If the problem continues, you need to disconnect the phone's Bluetooth pairing and unbind the vehicle, then reconnect the app and re-bind the vehicle.

Troubleshooting

component	Symptom of failure	solution
Horn malfunction	Press the horn switch, but the horn does not work.	Check if the wiring plug is loose. If the problem cannot be resolved, please contact after-sales service.
DC-DC	After reading the NFC card, the bottom screen of the meter lights up faintly (or remains very dim), accompanied by one beep; the whole vehicle can run normally; the headlight or horn can work normally.	① Check if the DCDC connector is properly plugged in. If the problem continues, it is recommended to contact after-sales service for the following inspections: ② Replace the DCDC; ③ If the fault still exists after replacing the DCDC, the main cable needs to be replaced.
Battery	The power of the vehicle is limited or weakened.	①When the temperature drops below 10°C, the battery's discharge capacity will significantly weaken. After riding for a certain distance, as the battery temperature rises, the discharge capacity will gradually increase. ②When the SOC is close to or lower than 30%, the battery's discharge capacity will be limited. It is recommended to ride after charging.
	The battery SOC cannot reach 100% during charging.	① Check if the charger shows full charge or a green light; ② Whether there is a charging parameter interface on the meter screen when the vehicle is powered on; ③When all the above conditions are met, plug in the charger again, hold down the M switch on the meter for a long time to exit the charging interface, confirm whether there are any fault codes on the meter, and then contact after-sales service to solve problem.



Troubleshooting

component	Symptom of failure	solution
Motor	There is an abnormal noise when rotating.	<ol style="list-style-type: none"> ① Check whether the abnormal noise is caused by the chain guide, and manually adjust the position of the chain guide. ② Check the condition of the gear oil: The gear oil level can be seen by checking the motor gear oil dipstick.
NFC	The new NFC card cannot be read.	<p>Enter the meter menu, select "NFC Settings" to register the card. If the problem continues, please contact after-sales service.</p> <ol style="list-style-type: none"> ① Check if the tilt sensor is loose from its mounting bracket (located in front of the motor). ② If the sensor is properly installed, disconnect the tilt sensor connector and check whether the fault continues: <ul style="list-style-type: none"> - if the fault disappears, the tilt sensor needs to be replaced. - if the fault continues, further inspection of the main cable and harness control is required.
Tilt sensor	When the vehicle is in normal driving or parked, the meter displays a pop - up window prompting "Please note that the vehicle has rolled over" and it cannot be restored.	
Brake Switch	After the new vehicle is fully assembled, it powers on normally. When the side stand is retracted, following a "cl" beep from the buzzer, the meter display directly exits P gear and enters the "Ready". All vehicle functions are normal with no fault codes displayed, but the vehicle fails to start when the throttle grip is twisted.	<ol style="list-style-type: none"> ① Check if the rubber plug at the rotating position of the brake lever has been removed. ② Check if the brake switch is installed in place. ③ Check if the brake lever rebounds properly.

8.2 List of Fault Codes

When a vehicle malfunction occurs, a malfunction indicator will be displayed on the meter along with a fault code (refer to page 19).

Fault Code	Cause	Solution
E0001	The CAN communication of the meter is disconnected.	Check if the meter plug is loose. If the problem continues, please contact after-sales service.
E0101	The battery is overcharged and the total voltage is too high.	Unplug the charger or install the battery and ride to solve the problem; if the problem continues, please contact after-sales service.
E0102	The battery is over-discharged and the total voltage is too low.	Using the original charger for charging to solve the problem; if the problem continues, please contact after-sales service.
E0103	The battery is overcharged, and the voltage of a single cell is too high.	Unplug the charger or install the battery and ride to solve the problem; if the problem continues, please contact after-sales service.
E0104	The battery is overcharged, and the voltage of a single cell is too low.	Using the original charger for charging to solve the problem; if the problem continues, please contact after-sales service.
E0105	The battery voltage is unbalanced.	Using the original charger for charging to solve the problem; if the problem continues, please contact after-sales service.
E0106	The battery temperature is too high to be charged.	The problem can be solved when the battery temperature drops to the normal charging range; if the problem continues, please contact after-sales service.
E0107	The battery temperature is too low to be charged.	The problem can be solved when the battery temperature rises to the normal charging range; if the problem continues, please contact after-sales service.

Troubleshooting

Fault Code	Cause	Solution
E0108	The insulation resistance value of the vehicle is too low with electricity leakage.	It is recommended to contact the after-sales service for troubleshooting. The troubleshooting steps are as follows: ① Power off the entire vehicle and remove the motor's three-phase wires and signal wires. Power on the vehicle; check if the fault code exists (other fault codes can be ignored at this time). If the fault code disappears, the motor needs to be replaced. ② If the fault code exists, further troubleshooting is required by sequentially replacing the following components (Battery, DDC, MCU, Harness wire).
E0109	The battery discharge temperature is too high.	The problem can be solved when the battery temperature drops to the normal charging range; if the problem continues, please contact after-sales service.
E0110	The battery discharge temperature is too low.	The problem can be solved when the battery temperature rises to the normal charging range; if the problem continues, please contact after-sales service.
E0111	The temperature difference between the highest and lowest cell of the battery is too large.	The problem can be solved when the battery temperature drops to the normal range; if the problem continues, please contact after-sales service.
E0112	The temperature difference between the highest and lowest cell of the battery is too large when the battery is discharging.	The problem can be solved when the battery temperature drops to the normal range; if the problem continues, please contact after-sales service.
E0113	The battery discharge current is too high.	Check whether the vehicle can ride normally or whether there is a short circuit. Reinstalling the battery can solve the problem; if the problem continues, please contact after-sales service.

Troubleshooting

Fault Code	Cause	Solution
E0114	The battery charging current is too high.	Check if the charger is original. Inspect whether the charging port is short-circuited. Re-plugging the charging plug can solve the problem; if the problem continues, please contact after-sales service.
E0115	The battery is overdischarged seriously.	Using the original charger for charging to solve the problem; if the problem continues, please contact after-sales service.
E0116	The signal acquisition of the internal cells of the battery is disconnected.	Please contact after-sales service.
E0117	The battery charging MOS is damaged.	
E0118	The battery discharging MOS is damaged.	
E0119	The battery temperature acquisition signal is disconnected.	
E0120	The temperature of the charging MOS is too high.	
E0121	The temperature of the discharging MOS is too high.	The problem can be solved when the battery temperature drops to the normal range; if the problem continues, please contact after-sales service.
E0122	There is an error occurs in IC.	Please contact after-sales service.
E2141	When the controller temperature reaches 90°C(194°F), the power will be reduced (the electronic control malfunction indicator will flash); when the temperature reaches 130°C (212°F) , the power will be off with P gear.	Turn off the power, wait for more than 3 minutes, and power on again to reset the fault. If not resolved, contact after-sales service to replace the controller.
E2142	The electronic control system does not receive the battery CAN message within 3 seconds: ① The battery communication is disturbed. ② The battery CAN wire is broken.	Determine if the battery CAN line is disconnected. If no disconnection is found, power on again to reset the fault. If not resolved, contact after-sales service to replace the main cable, power cable, and battery in sequence.

Troubleshooting

Fault Code	Cause	Solution
E2143	The current of the controller exceeds the maximum limit of software or hardware.	Power on again to reset the fault. If the problem continues, contact after-sales service to replace the controller.
E2144	The bus voltage remains below 77V for more than 1 second: ① Low SOC. ② Insufficient remaining battery capacity, with rapid degradation and high loss.	Power on again and reset the fault when the bus voltage is higher than 80V, and charge the battery in time. If the battery cannot be charged, it may be damaged and needs to be replaced. If the problem continues after the battery is fully charged, the controller needs to be replaced.
E2145	① The energy retrieval is disabled if the vehicle speed exceeds the maximum speed when going downhill. ② The controller has a hardware fault. ③ Driving the motor when the wires of motor position sensors A, B, Z are broken or the position sensor signals are abnormal.	Power on again to reset the fault. If the problem continues, contact after-sales service to replace the controller.
E2146	① The wire of throttle grip is broken or damaged. ② The speed control signal of the main cable is disconnected. ③ The controller has a hardware fault.	Check if the signal wire of the throttle grip is broken. If the problem continues, contact after-sales service to replace the throttle grip, main cable, controller, etc. in sequence.
E2147	The hardware of the current sensor is damaged.	Power on again to reset the fault. If the problem continues, contact after-sales service to replace the controller.
E2148	The power MOSFET of the controller is damaged.	Power on again to reset the fault. If the problem continues, contact after-sales service to replace the controller.
E2149	The temperature sensor of the controller is damaged.	Power on again to reset the fault. If the problem continues, contact after-sales service to replace the controller.

Troubleshooting

Fault Code	Cause	Solution
E2150	As the signal voltage of the throttle grip is abnormal, pressing the start switch will trigger this fault to prevent the vehicle from running away.	Return the throttle grip to its original position and then press the start switch. If the problem continues, contact after-sales service to replace the throttle grip.
E2151	When the vehicle is powered on, it is detected that the battery is in a non - dischargeable state.	Power on again to reset the fault. If the problem continues, contact after-sales service to replace the power cable and battery in sequence.
E3161	① Motor overload output; low speed with high torque; ② Motor mechanical malfunction; mechanical jamming between the bearing and the rotating shaft.	Release the throttle completely and the vehicle will return to normal. If the problem continues, contact after-sales service to replace the motor and controller in sequence.
E3162	When the motor temperature reaches 120°C(248°F), the power will be reduced (the electronic control malfunction indicator will flash); when the temperature reaches 130°C (266°F), the power will be off with vehicle P gear.	Power off and wait for more than 2 minutes, then power on again to reset the fault. If the problem continues, contact after-sales service to replace the motor and controller in sequence.
E3163	① The motor temperature signal wire of the main cable is broken. ② The internal temperature sensor of the motor is damaged or its temperature signal wire is broken. ③ The motor temperature sampling circuit of the controller is abnormal.	Check if the motor temperature signal wire is broken. If the problem continues, contact after-sales service to replace the main cable, motor, and controller in sequence.
E3164	① The motor position sensor is damaged or its signal wire is broken. ② The signal wire of the motor position sensor of the main cable is broken. ③ The controller has a hardware fault.	First, check if the wire of the motor position sensor is broken. If no breakage is found, power on again to reset the fault. If the problem continues, contact after-sales service to replace the wiring harness, motor, and controller in sequence.
E3165	Any one or more phases of the motor's three-phase lines U, V, W are broken.	Check whether the three-phase wires are broken. If the problem continues, contact the after-sales service to replace the motor and controller in sequence.

9. Other Information

9.1 Caring for Your Vehicle

Regular cleaning and polishing help to ensure the long service life of your vehicle. A clean vehicle makes it easier to find potential faults.

After riding, allow the motor, brakes and other high-temperature parts to cool down before cleaning.

Do not use high-pressure cleaners to clean the vehicle, as it may damage the moving parts or electrical components.

Water adversely affects braking effectiveness. After cleaning the brakes, ride at low speed and apply the brakes intermittently to help dry the brakes.

Do not clean the lithium battery or battery terminals with water or detergents.

Do not clean the area under the seat with water, as this may cause a short circuit in the electrical components.

Do not wax the tires, brakes or matte finishes.

Wash your vehicle with cold water immediately after riding on roads with high content of salt spray or near the sea. Do not use warm water, as it may accelerate the chemical reactions with salt and increase corrosion.

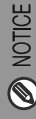

NOTICE

9.2 Storing Your Vehicle

If you store the vehicle outdoors for an extended period of time, use a motorcycle cover to protect the entire vehicle.

If you intend to store the vehicle for an extended period of time, follow these guidelines:

- To prevent deterioration of the performance of the power battery, store your vehicle in a dry, well-ventilated, and shaded place.
- Check the battery level at least once every two months and recharge as necessary.
- After rain, remove the motorcycle cover to keep the vehicle dry.

Other Information

9.3 Transporting Your Vehicle

If you need to transport your vehicle, use a dedicated motorcycle trailer, or a flatbed truck or trailer equipped with a loading platform, lifting platform and tie-downs.

When towing the vehicle, do not allow the wheels to touch the ground.

Towing the vehicle may seriously damage its drive train.

If you need to move the vehicle manually, make sure to wear protective gloves. Take care to prevent your body parts from being pinched by the vehicle components during transport, especially by the wheel hub, front and rear brakes.



NOTICE

Environmental Protection

Use environmental-friendly cleaning agents.

We recommend using biodegradable detergents when washing your vehicle. Avoid cleaning agents that contain chlorofluorocarbons, which may damage the atmospheric ozone layer.

Recycle Wastes





This vehicle uses lithium battery, which can harm the environment if not properly disposed of or discarded. If your vehicle requires replacement of battery or accessories, or is ready for disposal, contact after-sales service.

Waste Liquid Disposal

Dispose of waste liquids (such as used brake fluid) properly to avoid environmental pollution.

10. Specifications

General Specifications

Image				
Model	AT180K-35	AT180K-35X	AT180K-35L/AT180K-35H	AT180K-35K
L x W x H (mm)	1920x780x1150	1885x780x1150	1980x825x1195	1980x825x1150
Wheelbase (mm)	1285	1295	1285	1285
Cur weight (without battery) (lbs)	148	150	151	151
Maximum load capacity (lbs)	220	220	220	220
Passenger capacity (person)	1	1	1	1
Seat height (mm)	900	900	840	900
Minimum ground clearance (mm)	351	354	280	350
Tire specification	70/100-19	70/100-19	70/100-19	70/100-19
Tire pressure (kPa)	80/100-19	90/100-16	80/100-19	80/100-19
Brake type	Front Disc/Rear 225	Front Disc/Left Rear Disc	Front Disc/Left Rear Disc	Front Disc/Left Rear Disc
Rear shock absorber type	Inverted shock absorber	Inverted shock absorber	Inverted shock absorber	Inverted shock absorber
Rear shock absorber type	Alfiteag rear single shock absorber	Alfiteag rear single shock absorber	Alfiteag rear single shock absorber	Alfiteag rear single shock absorber
Maximum speed (km/h)	130	100	45/105	120
NEEDC	110 km/45 kph	110 km/45 kph	110 km/45 kph	110 km/45 kph
Climbing ability	40°/35 km/h	40°/35 km/h	40°/35 km/h	40°/35 km/h
Motor				
Motor type	Mid-drive motor	Mid-drive motor	Mid-drive motor	Mid-drive motor
Drive method	Chain drive	Chain drive	Chain drive	Chain drive
Maximum power (kW)	22	22	4/20	20
Rated power (kW)	8	8	4/8	8
Maximum torque (Nm)	84	84	72	72
Gear ratio	7.401 (2.467 motor 13/58 sprocket)	8.35 (2.467 motor 13/44 sprocket)	7.401 (2.467 motor 13/59 sprocket)	7.401 (2.467 motor 13/59 sprocket)
Rear output torque (Nm)	622	701	533	533

Specifications

➤ Battery

	Lithium battery	Lithium battery	Lithium battery	Lithium battery
Battery type	Lithium battery	Lithium battery	Lithium battery	Lithium battery
Total capacity (Ah)	35	35	35	35
Total voltage (V)	98	98	98	98
Total weight (lbs)	48	48	48	48
Cell type	Ternary/21700	Ternary/21700	Ternary/21700	Ternary/21700

➤ Charger

Charging specifications	98 V 12 A	98 V 12 A	98 V 14 A	98 V 14 A
Charging method	Off-board	Off-board	Off-board	Off-board
Charging time (h)	3	3	2.5	2.5

➤ Electrical components

Headlight/position light	LED	LED	LED	LED
Front/rear turn signal light	O	O	LED	LED
Tail light/license plate light	O	O	LED	LED
Rear view mirror	O	O	●	●
Front/rear reflector	O	O	●	●
USB port	●	●	●	●
Type-C port	●	●	●	●
Communication protocol	CAN2.0B	CAN2.0B	CAN2.0B	CAN2.0B
OTA	●	●	●	●
Meter	3.5-inch TFT display	3.5-inch TFT display	3.5-inch TFT display	3.5-inch TFT display
Kickstand switch	●	●	●	●
NFC start	●	●	●	●
P mode parking	●	●	●	●
Safety device	Tilt power-off module	Tilt power-off module	Tilt power-off module	Tilt power-off module
Insulation monitoring	●	●	●	●



11. Electrical Schematic

AT80K-35/AT80K-35X

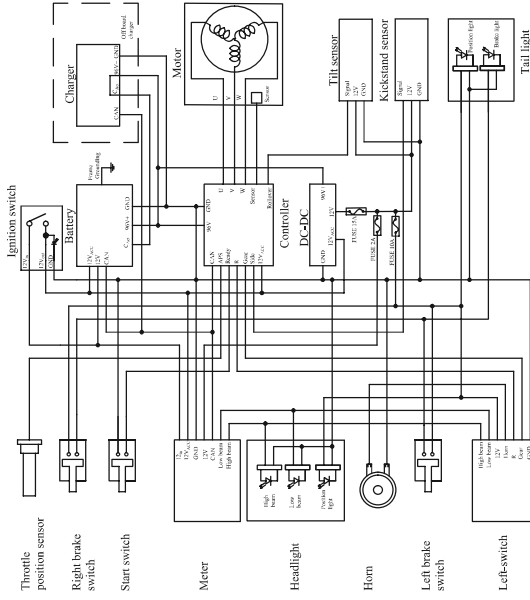



Electrical Schematic

AT80K-35L/AT80K-35H/AT80K-35K

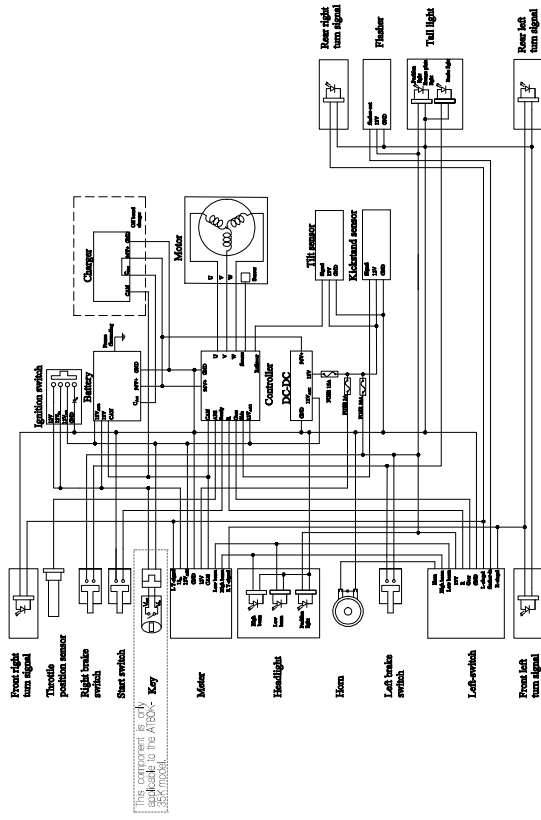

12. Index

A	Accessories and Modifications	13
	App	9
B	Battery Installation	47
	Battery Removal	47
	Bluetooth Function	38
	Brake Disc	58
	Brake Fluid	57
	Brake Pad	58
	Braking	43
C	Caring for Your Vehicle	68
	Chain	60
	Charger	48
	Charging Port	21
	Controller	54
E	Electrical Components	16
	Electrical Schematic	72
F	Frame Number	7
H	Handlebar Switches	17
	How to Charge	49
I	If You are Involved in a Crash	11
	Important Information	4
	Introduction	1
K	Kickstand Power-off Switch	23



Index

L	List of Fault Codes	63
	Loading Guidelines	13
M	Main Components	14- 15
	Maintenance Schedule	52
	Meter Settings	24
	Meters	18
	Motor	54
	Motor Number	8
N	NFC Card	20
	NFC Settings	34
O	OTA Update	38
	Overview	4
P	Parking	44
	Power Battery	46
	Pre-Ride Inspection	40
	Product Plate	7
	Product Plate (Hyperide-S)	7
R	Riding	42
	Riding Equipments	10
	Riding Guidelines	68
	Riding Mode	40
	Right Handlebar Switch	20

Index

S	
Safety Guidelines	10
Seat	23
Spare Mechanical Key	20
Specifications	70
Start the Vehicle	41
Storing Your Vehicle	68
T	
Throttle Grip	59
Tips for Safe Riding	11
Tire	54-55
Transporting Your Vehicle	69
Troubleshooting	62
Turn Off the Vehicle	44
U	
USB Charging Port	22

V	
Vehicle Information	7-9
Vehicle Overview	14
Vehicle Warning Labels	5



Index



Altis Powersports Inc.
www.altispowersports.com